

Toy Soldier Craft

HOW TO ASSEMBLE YOUR CHRISTMAS CARD:

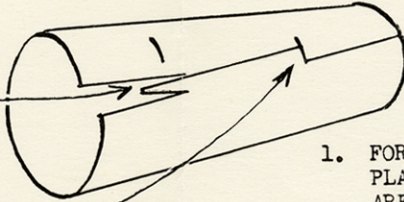

1. FORM CYLINDER OF SOLDIER'S TORSO PLACING TIPS IN SLOTS. WHEN THEY ARE IN, FOLD THEM DOWN ON THE INSIDE TO LOCK.

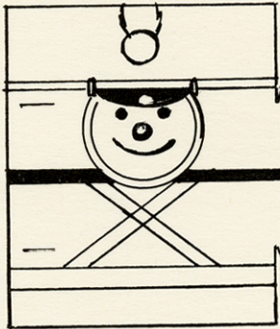
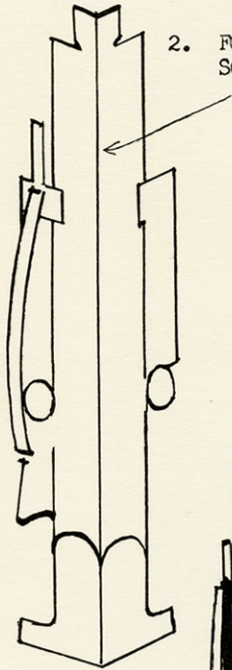

2. FOLD BACK 'LEGS AND ARMS' SECTION SO THAT IT LOOKS LIKE THIS.

3. SLIDE CYLINDER OVER BODY, LOCKING SHOULDERS IN SLOTS ON CYLINDER.

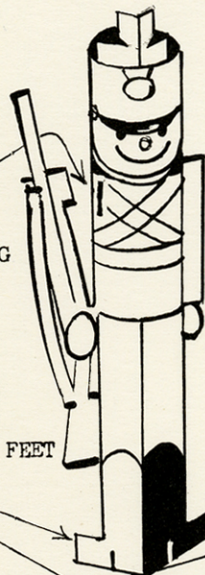

4. PLACE LEGS OVER TURNED-UP FEET AND LOCK IN SLOTS.

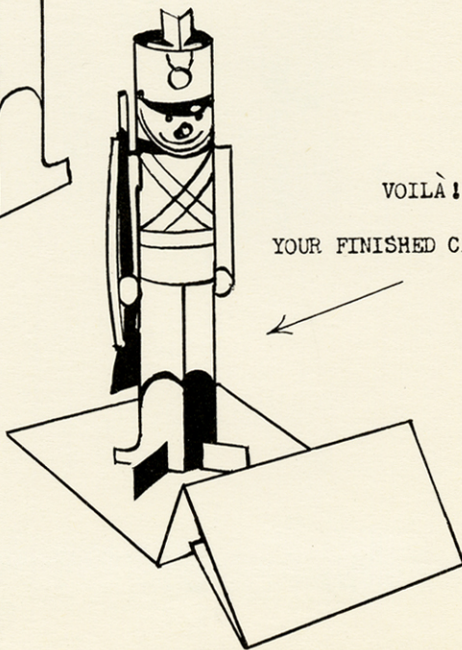

VOILÀ!

YOUR FINISHED CARD - OK?

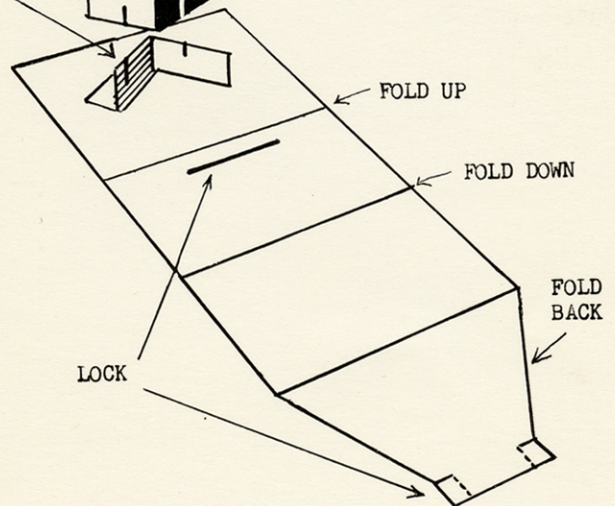

Toy Soldier Craft

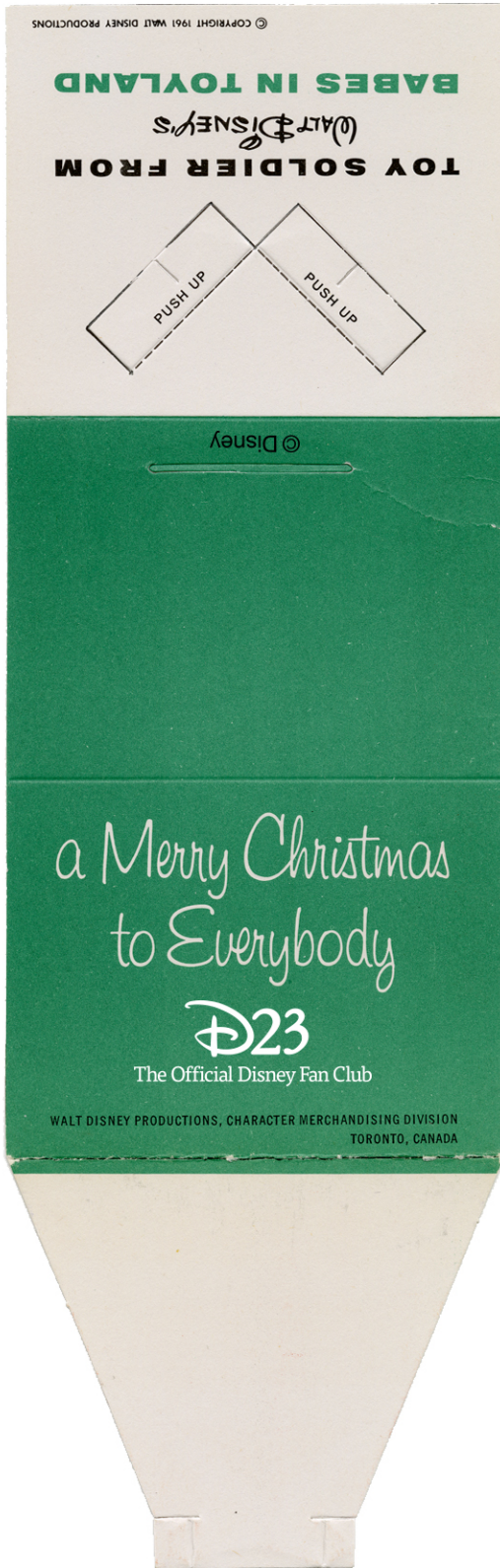

1



2

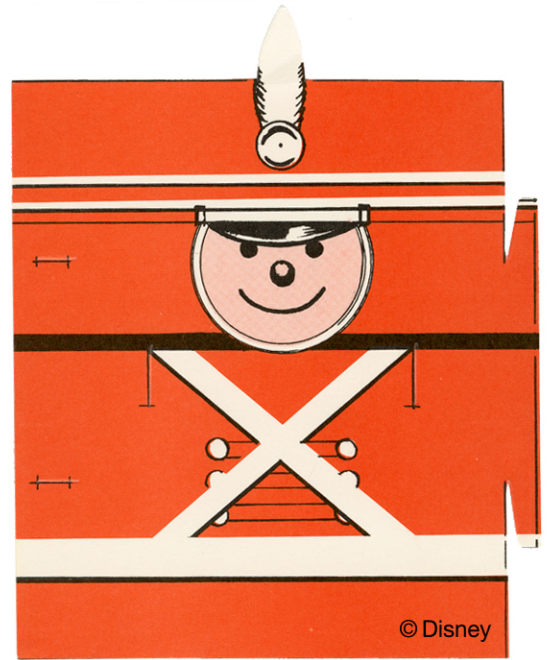

3